

Винт Vira метрична резба с фрезенкова глава кръстат шлиц M2x12 мм, 7.0, A2, 0.4 мм, DIN 965



DIN 965 H sim. UNI 7688 EN ISO 7046

Vite a testa svasata piana con impronta a croce H (Phillips)

Cross recessed H (Phillips) countersunk head screw

Disponibile/Available :

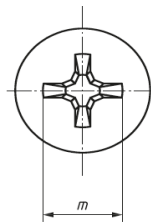
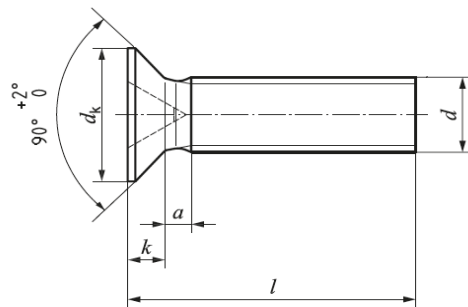

d	M1,6	M2	M2,5	M3	M4	M5	M6	M8	M10	
P*	0,35	0,4	0,45	0,5	0,7	0,8	1,0	1,25	1,5	
a	max.	0,7	0,8	0,9	1	1,4	1,6	2	3	
dk	nom.= max.	3	3,8	4,7	5,6	7,5	9,2	11	14,5	
	min.	2,75	3,5	4,4	5,3	7,14	8,84	10,57	14,07	
k	max.	0,96	1,2	1,5	1,65	2,2	2,5	3	5	
Cross recess	Recess	no.	0		1		2		3	4
	m	ref.	1,7	2,35	2,7	2,9	4,4	4,6	6,6	8,7
	Type H	max.	0,91	1,25	1,55	1,8	2,4	2,77	2,6	3,3
penetration	min.	0,66	0,95	1,25	1,5	1,9	3,27	2,1	2,8	4,8

* P è il passo del filetto

*P is the pitch of the thread.

last edit 24/07/2019 pag.1/2

DRAWING N. 1093

l/d	M1,6	M2	M2,5	M3	M4	M5	M6	M8	M8
3	1,6x3	2x3	2,5x3						
4	1,6x4	2x4	2,5x4	3x4					
5	1,6x5	2x5	2,5x5	3x5	4x5				
6	1,6x6	2x6	2,5x6	3x6	4x6	5x6			
8	1,6x8	2x8	2,5x8	3x8	4x8	5x8	6x8		
10	1,6x10	2x10	2,5x10	3x10	4x10	5x10	6x10	8x10	10x10
12	1,6x12	2x12	2,5x12	3x12	4x12	5x12	6x12	8x12	10x12
(14)	/	2x14	2,5x14	3x14	4x14	5x14	6x14	/	/
16	1,6x16	2x16	2,5x16	3x16	4x16	5x16	6x16	8x16	10x16
(18)	/	2x18	2,5x18	3x18	4x18	5x18	6x18	/	/
20	1,6x20	2x20	2,5x20	3x20	4x20	5x20	6x20	8x20	10x20
(22)			/	3x22	4x22	5x22	/	/	/
25			2,5x25	3x25	4x25	5x25	6x25	8x25	10x25
(28)			/	/	/	/	/	/	/
30			2,5x30	3x30	4x30	5x30	6x30	8x30	10x30
35				3x35	4x35	5x35	6x35	8x35	10x35
40				3x40	4x40	5x40	6x40	8x40	10x40
45				3x45	4x45	5x45	6x45	8x50	10x50
50				3x50	4x50	5x50	6x50	8x50	10x50
55					4x55	5x55	6x55	/	/
60					4x60	5x60	6x60	8x60	10x60
70					4x70	5x70	6x70	8x70	10x70
80					4x80	5x80	6x80	8x80	
90						5x90	6x90	8x90	
100						5x100	6x100	8x100	

Le lunghezze tra parentesi sono sconsigliate
 Sizes in parentheses should be avoided if possible.

Le lunghezze standard sono quelle tra le due linee in grassetto.
 The range of commercial lengths is between the bold stepped lines.

last edit 24/07/2019	pag. 2/2
DRAWING N. 1093	

Продукт: [Винт Vira метрична резба с фрезенкова глава кръстат шлиц M2x12 мм, 7.0, A2, 0.4 мм, DIN 965](#)

Категория: [Болтове и винтове метрична резба](#)

Бранд: [Vira](#)

Категория бранд: [Винт Vira](#)